

User's Manual



System 5cr Plus

System Switcher with Stereo Audio and Projector Control

Precautions

Safety Instructions • English



This symbol is intended to alert the user of important operating and maintenance (servicing) instructions in the literature provided with the equipment.



This symbol is intended to alert the user of the presence of uninsulated dangerous voltage within the product's enclosure that may present a risk of electric shock.

Caution

Read Instructions • Read and understand all safety and operating instructions before using the equipment.

Retain Instructions • The safety instructions should be kept for future reference.

Follow Warnings • Follow all warnings and instructions marked on the equipment or in the user information.

Avoid Attachments • Do not use tools or attachments that are not recommended by the equipment manufacturer because they may be hazardous.

Consignes de Sécurité • Français



Ce symbole sert à avertir l'utilisateur que la documentation fournie avec le matériel contient des instructions importantes concernant l'exploitation et la maintenance (réparation).



Ce symbole sert à avertir l'utilisateur de la présence dans le boîtier de l'appareil de tensions dangereuses non isolées posant des risques d'électrocution.

Attention

Lire les instructions • Prendre connaissance de toutes les consignes de sécurité et d'exploitation avant d'utiliser le matériel.

Conservier les instructions • Ranger les consignes de sécurité afin de pouvoir les consulter à l'avenir.

Respecter les avertissements • Observer tous les avertissements et consignes marqués sur le matériel ou présentés dans la documentation utilisateur.

Éviter les pièces de fixation • Ne pas utiliser de pièces de fixation ni d'outils non recommandés par le fabricant du matériel car cela risquerait de poser certains dangers.

Sicherheitsanleitungen • Deutsch



Dieses Symbol soll dem Benutzer in der im Lieferumfang enthaltenen Dokumentation besonders wichtige Hinweise zur Bedienung und Wartung (Instandhaltung) geben.



Dieses Symbol soll den Benutzer darauf aufmerksam machen, daß im Inneren des Gehäuses dieses Produktes gefährliche Spannungen, die nicht isoliert sind und die einen elektrischen Schock verursachen können, herrschen.

Achtung

Lesen der Anleitungen • Bevor Sie das Gerät zum ersten Mal verwenden, sollten Sie alle Sicherheits- und Bedienungsanleitungen genau durchlesen und verstehen.

Aufbewahren der Anleitungen • Die Hinweise zur elektrischen Sicherheit des Produktes sollten Sie aufbewahren, damit Sie im Bedarfsfall darauf zurückgreifen können.

Befolgen der Warnhinweise • Befolgen Sie alle Warnhinweise und Anleitungen auf dem Gerät oder in der Benutzerdokumentation.

Keine Zusatzgeräte • Verwenden Sie keine Werkzeuge oder Zusatzgeräte, die nicht ausdrücklich vom Hersteller empfohlen wurden, da diese eine Gefahrenquelle darstellen können.

Instrucciones de seguridad • Español



Este símbolo se utiliza para advertir al usuario sobre instrucciones importantes de operación y mantenimiento (o cambio de partes) que se desean destacar en el contenido de la documentación suministrada con los equipos.



Este símbolo se utiliza para advertir al usuario sobre la presencia de elementos con voltaje peligroso sin protección aislante, que puedan encontrarse dentro de la caja o alojamiento del producto, y que puedan representar riesgo de electrocución.

Precaucion

Leer las instrucciones • Leer y analizar todas las instrucciones de operación y seguridad, antes de usar el equipo.

Conservar las instrucciones • Conservar las instrucciones de seguridad para futura consulta.

Obedecer las advertencias • Todas las advertencias e instrucciones marcadas en el equipo o en la documentación del usuario, deben ser obedecidas.

Evitar el uso de accesorios • No usar herramientas o accesorios que no sean específicamente recomendados por el fabricante, ya que podrían implicar riesgos.

Warning

Power sources • This equipment should be operated only from the power source indicated on the product. This equipment is intended to be used with a main power system with a grounded (neutral) conductor. The third (grounding) pin is a safety feature, do not attempt to bypass or disable it.

Power disconnection • To remove power from the equipment safely, remove all power cords from the rear of the equipment, or the desktop power module (if detachable), or from the power source receptacle (wall plug).

Power cord protection • Power cords should be routed so that they are not likely to be stepped on or pinched by items placed upon or against them.

Servicing • Refer all servicing to qualified service personnel. There are no user-serviceable parts inside. To prevent the risk of shock, do not attempt to service this equipment yourself because opening or removing covers may expose you to dangerous voltage or other hazards.

Slots and openings • If the equipment has slots or holes in the enclosure, these are provided to prevent overheating of sensitive components inside. These openings must never be blocked by other objects.

Lithium battery • There is a danger of explosion if battery is incorrectly replaced. Replace it only with the same or equivalent type recommended by the manufacturer. Dispose of used batteries according to the manufacturer's instructions.

Avertissement

Alimentations • Ne faire fonctionner ce matériel qu'avec la source d'alimentation indiquée sur l'appareil. Ce matériel doit être utilisé avec une alimentation principale comportant un fil de terre (neutre). Le troisième contact (de mise à la terre) constitue un dispositif de sécurité : n'essayez pas de le contourner ni de le désactiver.

Déconnexion de l'alimentation • Pour mettre le matériel hors tension sans danger, déconnectez tous les cordons d'alimentation de l'arrière de l'appareil ou du module d'alimentation de bureau (s'il est amovible) ou encore de la prise secteur.

Protection du cordon d'alimentation • Acheminer les cordons d'alimentation de manière à ce que personne ne risque de marcher dessus et à ce qu'ils ne soient pas écrasés ou pincés par des objets.

Réparation-maintenance • Faire exécuter toutes les interventions de réparation-maintenance par un technicien qualifié. Aucun des éléments internes ne peut être réparé par l'utilisateur. Afin d'éviter tout danger d'électrocution, l'utilisateur ne doit pas essayer de procéder lui-même à ces opérations car l'ouverture ou le retrait des couvercles risquent de l'exposer à de hautes tensions et autres dangers.

Fentes et orifices • Si le boîtier de l'appareil comporte des fentes ou des orifices, ceux-ci servent à empêcher les composants internes sensibles de surchauffer. Ces ouvertures ne doivent jamais être bloquées par des objets.

Lithium Batterie • Il a danger d'explosion s'il y a un remplacement incorrect de la batterie. Remplacer uniquement avec une batterie du même type ou d'un type équivalent recommandée par le constructeur. Mettre au rebut les batteries usagées conformément aux instructions du fabricant.

Vorsicht

Stromquellen • Dieses Gerät sollte nur über die auf dem Produkt angegebene Stromquelle betrieben werden. Dieses Gerät wurde für eine Verwendung mit einer Hauptstromleitung mit einem geerdeten (neutralen) Leiter konzipiert. Der dritte Kontakt ist für einen Erdanschluß, und stellt eine Sicherheitsfunktion dar. Diese sollte nicht umgangen oder außer Betrieb gesetzt werden.

Stromunterbrechung • Um das Gerät auf sichere Weise vom Netz zu trennen, sollten Sie alle Netzkabel aus der Rückseite des Gerätes, aus der externen Stromversorgung (falls dies möglich ist) oder aus der Wandsteckdose ziehen.

Schutz des Netzkabels • Netzkabel sollten stets so verlegt werden, daß sie nicht im Weg liegen und niemand darauf treten kann oder Objekte darauf- oder unmittelbar dagegengestellt werden können.

Wartung • Alle Wartungsmaßnahmen sollten nur von qualifiziertem Servicepersonal durchgeführt werden. Die internen Komponenten des Gerätes sind wartungsfrei. Zur Vermeidung eines elektrischen Schocks versuchen Sie in keinem Fall, dieses Gerät selbst öffnen, da beim Entfernen der Abdeckungen die Gefahr eines elektrischen Schlags und/oder andere Gefahren bestehen.

Schlitze und Öffnungen • Wenn das Gerät Schlitze oder Löcher im Gehäuse aufweist, dienen diese zur Vermeidung einer Überhitzung der empfindlichen Teile im Inneren. Diese Öffnungen dürfen niemals von anderen Objekten blockiert werden.

Lithium-Batterie • Explosionsgefahr, falls die Batterie nicht richtig ersetzt wird. Ersetzen Sie verbrauchte Batterien nur durch den gleichen oder einen vergleichbaren Batterietyp, der auch vom Hersteller empfohlen wird. Entsorgen Sie verbrauchte Batterien bitte gemäß den Herstelleranweisungen.

Advertencia

Alimentación eléctrica • Este equipo debe conectarse únicamente a la fuente/tipo de alimentación eléctrica indicada en el mismo. La alimentación eléctrica de este equipo debe provenir de un sistema de distribución general con conductor neutro a tierra. La tercera pata (puesta a tierra) es una medida de seguridad, no puntearía ni eliminarla.

Desconexión de alimentación eléctrica • Para desconectar con seguridad la acometida de alimentación eléctrica al equipo, desenchufar todos los cables de alimentación en el panel trasero del equipo, o desenchufar el módulo de alimentación (si fuera independiente), o desenchufar el cable del receptáculo de la pared.

Protección del cables de alimentación • Los cables de alimentación eléctrica se deben instalar en lugares donde no sean pisados ni apretados por objetos que se puedan apoyar sobre ellos.

Reparaciones/mantenimiento • Solicitar siempre los servicios técnicos de personal calificado. En el interior no hay partes a las que el usuario deba acceder. Para evitar riesgo de electrocución, no intentar personalmente la reparación/mantenimiento de este equipo, ya que al abrir o extraer las tapas puede quedar expuesto a voltajes peligrosos u otros riesgos.

Ranuras y aberturas • Si el equipo posee ranuras o orificios en su caja/alojamiento, es para evitar el sobrecalentamiento de componentes internos sensibles. Estas aberturas nunca se deben obstruir con otros objetos.

Batería de litio • Existe riesgo de explosión si esta batería se coloca en la posición incorrecta. Cambiar esta batería únicamente con el mismo tipo (o su equivalente) recomendado por el fabricante. Desachar las baterías usadas siguiendo las instrucciones del fabricante.

Quick Start — System 5cr Plus

Installation

Step 1

Turn off power to the input and output devices, and remove the power cords from them.

Step 2

Attach the switcher to the input and output devices. See "Power, video, and audio connections" in chapter 2 for details and diagrams.

Input options are:

- RGB for PC 1 and PC 2
- RGB, S-video, or composite video for Input 3
- S-video or composite video for Vid 1 & Vid 2
- Balanced/unbalanced stereo audio for all inputs

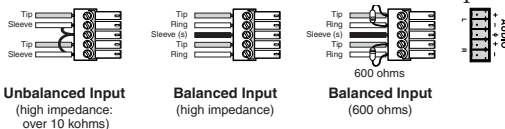

Output options are:

- RGBHV, RGBS, S-video, or composite video
- Balanced or unbalanced audio output via the line level or amplified outputs.

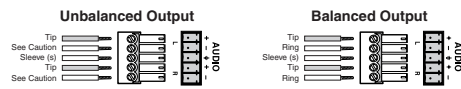

CAUTION Connect sleeve to ground (Gnd). Connecting the sleeve to a negative terminal will damage the circuits.

Step 3

With AC power still removed, connect control devices and accessories, including an RS-232 controller. See "Control device connections" in chapter 2 for details and wiring diagrams.

Step 4

Connect power cords and apply power to the switcher, the input and output devices, and the RS-232 controller.

Step 5

Set up (configure) the System 5cr Plus via front panel controls, RS-232 SIS commands, or the Windows-based control program. (See the next page.)

Front Panel Controls

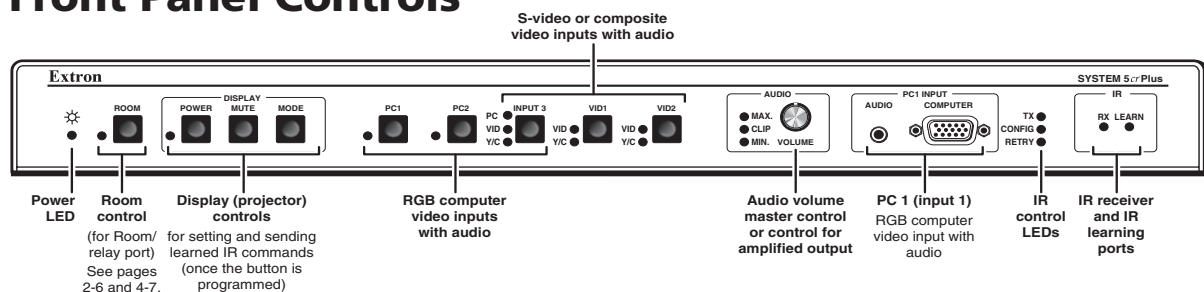

See "Front Panel Controls and Indicators" in chapter 3 for details. Refer to the Windows-based help program for details on settings.

Audio indicator LEDs (Max, Clip, and Min) — These light in response to changes made via the front panel volume control knob or RS-232 or control software.

Max/Min LEDs (red) – Light when the volume control knob reaches its maximum/minimum limit. They do not indicate anything about the audio level.

Clip LED (green) – Lights when the audio output level starts to peak (overdrive) and the signal is clipped, often when the input level is too high.

Volume control knob — Adjusts audio volume (audio gain) for the amplified output. It can be used as a master volume control for both audio outputs if all the inputs have the same level.

IR function LEDs (Tx, Config, Retry) — These indicate stand-alone functions and also are used in combinations during IR learning. See the LED codes table (page 3-7) for details on LED combinations.

Transmit (Tx) LED (green) – Lights when the System 5cr Plus transmits infrared signals.

Configure (Config) LED (amber) – Lights steadily when the System 5cr Plus is in setup (config.) mode.

Retry LED (red) – Lights when the System 5 does not recognize a command during IR learning.

Quick Start — System 5 α Plus, cont'd

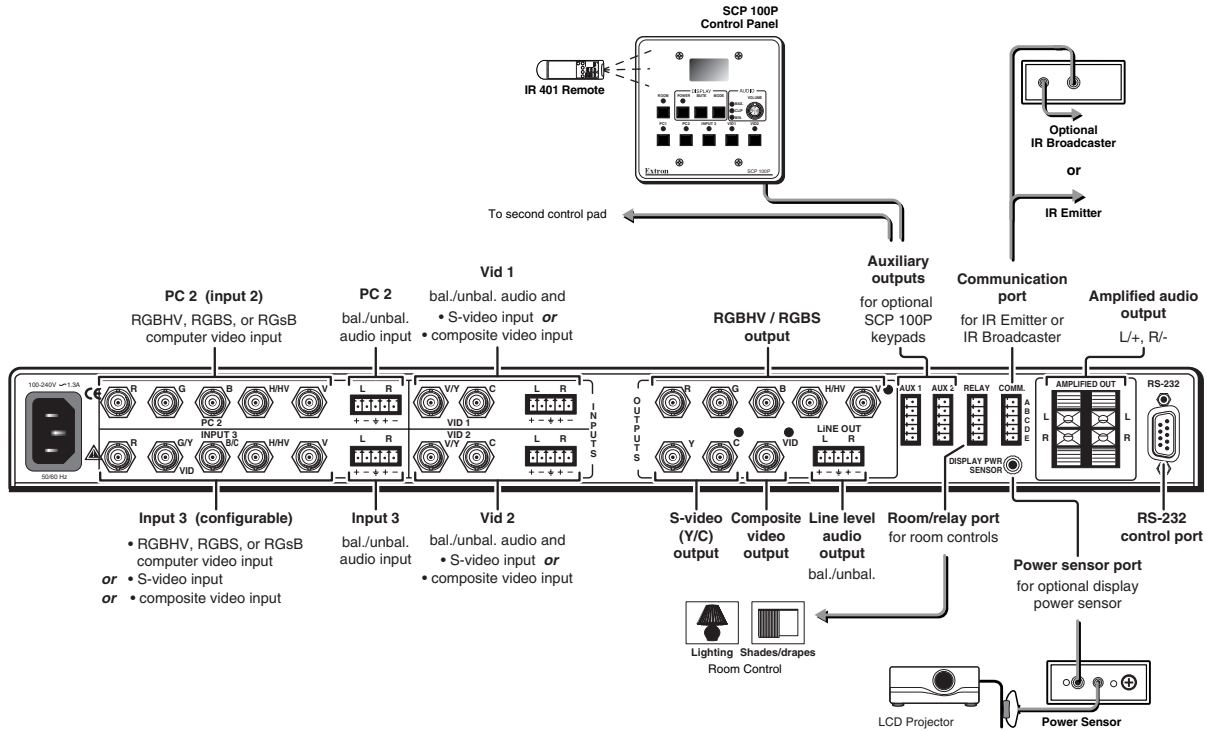

Key to LED Codes

Status	Setup mode is active	Ready to learn IR commands	Command has been learned	Try again	No IR subcarrier was received	Ready to learn the power-off command	Timeout exit to normal mode will occur
TX ●	Off	Off	Blinks once	Off	Off	Off	Blinks for 5 seconds
CONFIG ●	On	Blinking	On	On	On	Blinking	Blinks for 5 seconds
RETRY ●	Off	Off	Blinks once	Blinks once	Blinking	Blinking	Blinks for 5 seconds
What to do next	Configure a System 5 feature.	Aim projector's remote at IR learning port. Press a button for the function on the remote.	Continue with setup or exit to normal mode.	Press the same button again on the projector's IR remote.	Press the same System 5 Display button again, and press the IR remote's button again.	Double-click the System 5's Display Power button, then press the power button on the projector's remote.	Press any button to stay in setup mode.

Setup (Configuration) Procedure

Normal Mode

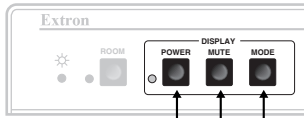

Press and hold all 3 DISPLAY buttons together for 2 seconds.

Press and hold all 3 DISPLAY buttons together for 2 seconds to return to Normal Mode.

or
Wait 20 seconds for the System 5 to time out to Normal Mode.

Setup (Config) Mode

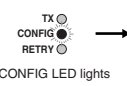

At any point after entering the setup mode, you can
Configure
any of the features described here,
in any order,
or
Wait 20 seconds to time out to Normal mode.

Clearing button configurations

Press the ROOM button twice. The ROOM LED blinks for 8 seconds. During that time, do one of the following:

Press any desired front panel button to clear & reset only that button's IR configuration.
or
Press all 3 DISPLAY buttons at the same time for 2 seconds to clear and reset all System 5 settings.

Setting audio input attenuation levels

With an active audio signal present, press an input's button twice in quick succession to adjust its audio input. The input's LED blinks.

Turn VOLUME knob up (clockwise) until CLIP LED is on or blinking fast. → Turn VOLUME knob down (counter-clockwise) until the CLIP LED is off or blinks occasionally as the level peaks. → Press the input's button once to save. Repeat for each audio input.

Selecting video formats

Press and hold the ROOM button while setting video formats.

Press INPUT3 to toggle between video formats for that input (an LED lights to indicate the selected format). Repeat for VID1 and VID2. Release the ROOM button.

Initiating IR learning

Press the DISPLAY, POWER, MUTE, or MODE button & hold it for 2 seconds.

CONFIG LED blinks

Point the projector's IR remote control at the System 5's IR LEARN port and firmly press the desired button on the remote.

TX ● CONFIG ● RETRY ● CONFIG LED lights steadily while TX & RETRY LEDs flash to indicate that the signal has been learned.

or

TX ● For POWER button configuration, if the TX LED is off and both the CONFIG and RETRY LEDs blink, the System 5 is ready to learn the power-off signal. Press the System 5's POWER button twice in quick succession, then aim the remote and press the IR remote's power button again.

or

TX ● If the TX LED is off and the CONFIG ● RETRY LED blinks once, press the RETRY ● POWER, MUTE, or MODE button and the IR remote's button again.

Repeat all steps for each DISPLAY button to be learned.

Table of Contents

Chapter 1 • Introduction	1-1
About this Manual	1-2
About the System 5α Plus	1-2
What is the System 5 α Plus?	1-2
Controlling an A/V system	1-2
Features and Options	1-4
Features	1-4
Options and accessories	1-5
Chapter 2 • Installation	2-1
Mounting the Switcher	2-2
Table/wall mounting	2-2
Rack mounting	2-2
Cabling and Panel Views	2-2
Power, video, and audio connections	2-2
Front panel inputs	2-2
Rear panel inputs	2-3
Outputs	2-4
Control device connections	2-5
Chapter 3 • Setup and Operation	3-1
Front Panel Controls and Indicators	3-2
Setting Up the System 5α Plus	3-4
Configuring the System 5 α Plus from the front panel	3-4
Clearing configurations	3-4
Setting audio input attenuation levels	3-5
Selecting video formats	3-5
Initiating IR learning	3-6
Key to LED codes	3-7
Remote Control of the System 5α Plus	3-7
Chapter 4 • Serial Communication	4-1
RS-232 Programmer's Guide	4-2
Host-to-switcher communications	4-2
Switcher-initiated messages	4-2
Error responses	4-2
Using the command/response tables	4-3
Command/response table for SIS commands	4-4
Command/response table for advanced instructions (for the control program for Windows)	4-5

Table of Contents, cont'd

Control Software for Windows	4-6
Installing the software	4-6
Using the software	4-6
Using the control program	4-6
Saving and restoring configurations	4-7
Using the help program	4-8
Downloading and using projector drivers	4-8
Appendix A • Appendix	A-1
Specifications	A-2
Part Numbers and Accessories	A-4
Included parts	A-4
Accessories	A-4
Firmware Upgrade Installation	A-5
Glossary	A-6

68-498-01 **Rev. D**
Printed in the USA
02 02



System 5*cr* Plus

Chapter One

Introduction

About this Manual

About the System 5*cr* Plus

Features and Options

Introduction

About this Manual

This manual discusses how to install, operate and configure the Extron System 5*cr* Plus switcher and how to operate the IR 401 infrared remote control that is included with the System 5*cr* Plus. For information on installing and operating related accessories, see the user's guides for the following products: Extron's Current/Display Power Sensor (part #68-391-01), IR Broadcaster (part #68-392-02), and SCP 100P Control Pad (part #68-390-01).

Throughout this manual the terms "System 5" and "System 5*cr* Plus" are used interchangeably to refer to the same product.

About the System 5*cr* Plus

What is the System 5*cr* Plus?

The System 5 switcher provides central control for small audio/video (A/V) installations. It offers video and audio switching, room control, and projector control. Each of these functions can be controlled by the front panel, by a hard-wired control pad (the SCP 100P), and by infrared remote control (the IR 401). The switcher can be used to control video and audio input settings; display functions such as power, video mute, and video modes; and room functions, such as lowering or raising a display screen or powering lights on or off. The System 5 also features the ability to "learn" infrared projector control commands.

The System 5 accepts two computer-video (RGB) inputs, two composite video or S-video inputs, and one RGB or composite video or S-video input, for a total of five video inputs. It also accepts five line-level stereo audio inputs.

The System 5 outputs computer video (RGBHV/RGBS/RGsB), or NTSC/PAL S-video or composite video to one display device. The System 5 also offers one line level (line out) and one amplified stereo audio output. Rear panel ports allow connection of the IR Emitter and/or the optional IR Broadcaster or hard-wired projector remote control, and addition of an optional display power sensor, remote control keypads and an RS-232 controller.

Controlling an A/V system

The System 5 and other devices can be controlled using one or more of these items:

- The front panel controls.
- A computer, a touch screen panel, or any other device that can send and receive serial communications through the RS-232 port. Extron's Simple Instruction Set™ (SIS™) is a set of simple keystroke commands that can be used with any such devices, and Extron's control software for Windows provides a graphical interface for controlling the switcher from a computer.
- Optional control pads (the SCP 100P) that can be mounted in a wall or podium and hard-wired to the System 5. Each SCP 100P replicates the front panel functions, and it can receive IR signals and pass them to the System 5.
- The IR 401 remote control, which can also perform all of the front panel functions.

For the System 5 to control a projector, it must be programmed. The System 5 can program itself by learning projector IR commands, or Extron's IR library of commands can be loaded into the System 5's memory. The IR library and the latest control software are available on the Extron web site at <http://www.extron.com>.

The System 5 learns new projector control commands from infrared (IR) signals it receives via its front panel IR ports. These commands are added to the panel functions. When a function is selected, the System 5 transmits the learned IR signal to the projector through the IR Emitter or the optional IR Broadcaster.

IR commands for the projector can be associated with each of the Display buttons (Power, Mute, and Mode) on the front panel, as well as with each of the five input buttons (PC 1, PC 2, Input 3, Vid 1, and Vid 2).

System 5cr Plus

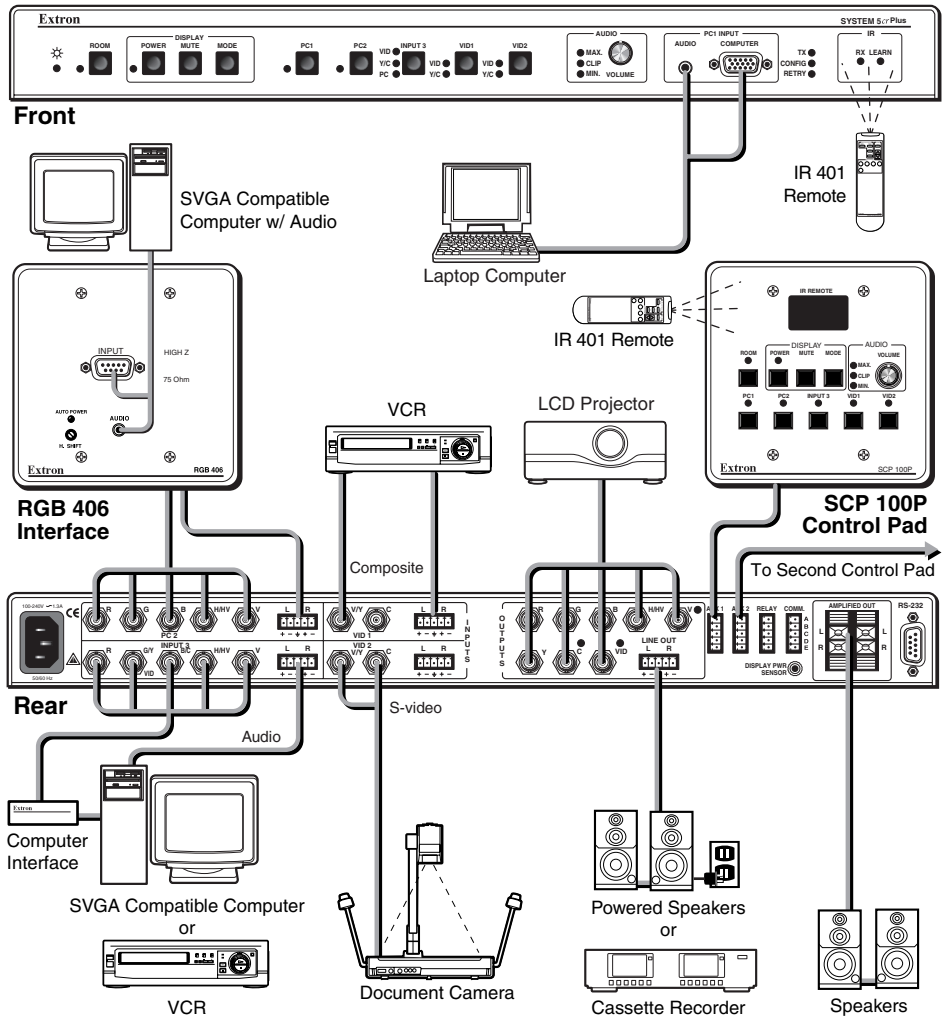

A typical System 5cr Plus application

Features and Options

Features

250 MHz (-3dB) video bandwidth

Five video inputs —

- **2 RGBHV/RGBS/RGsB computer video inputs** — A VGA 15-pin HD front panel connector (PC 1) allows direct connection of a laptop computer, and one set of five BNC rear panel connectors (PC 2) accepts inputs via an interface.
- **1 RGBHV/RGBS/RGsB computer video or S-video or composite video input** — A set of five BNC rear panel connectors (Input 3) accepts RGB input via an interface, or it can be configured to accept either S-video or composite video input instead of RGB input.
- **2 S-video or composite video inputs** — Inputs Vid 1 and Vid 2 each have two rear-panel BNC connectors.

One video output — A total of eight rear-panel BNC connectors provide connections for RGB, S-video, or composite video (NTSC/PAL) output. Only one output (RGB or S-video or composite video) is active at any one time, even if all three sets of BNCs are connected to the projector.

Five balanced/unbalanced stereo audio inputs — One front panel mini stereo jack and four rear panel captive screw ports accept audio inputs. Each input's levels can be individually preset, then adjusted by the master volume control.

Two stereo audio outputs —

- **Line level (line out) output** (balanced or unbalanced) via a captive screw terminal can be treated as a pre-amp. The output can be adjusted using the master volume control, or it can be set via RS-232 control to provide a fixed output level.
- **Amplified output** (unbalanced) of 24 watts (12 watts per channel with a 4 ohm load) or 12 watts (6 watts per channel with an 8 ohm load) is available for non-powered speakers via spring-loaded captive terminals. The master volume control adjusts the output level.

Audio breakaway — Audio and video can be switched separately via RS-232 control by using the Windows-based control program.

Three control methods — A computer or other RS-232 control device, the IR 401 remote control, or an SCP remote keypad can all be used to control the switcher.

RS-232 programming — The System 5 can be programmed using an RS-232 control device and SIS or Extron's control software for Windows.

Room control — The System 5 provides a relay for controlling a variety of items such as lighting, window coverings, or display screens.

Projector control — The System 5 can control the projector's display power, video mute, and mode functions.

IR command learning — The switcher can learn new IR commands from signals received through the front panel or downloaded from Extron's command library. Learned commands are output through the IR Emitter or IR Broadcaster.

IR Emitter — The included IR Emitter transmits learned commands and incoming infrared control signals to devices nearby.

Memory — All IR commands are stored in memory.

Triple-Action Switching™ — With this method, a blank screen is displayed while the System 5 switches between RGB inputs.

Versatile mounting options — The System 5 can be rack mounted, or it can be mounted under a desk or table, or on (against) a wall or the side of a desk. Mounting brackets are included.

Options and accessories

The System 5's optional equipment expands a user's ability to control system devices. Optional equipment includes:

- **Display power sensor** — This sensor (part #60-271-01) detects whether the projector's power is on or off in order to keep the System 5 and the projector in sync.
- **Remote control keypad** — Up to two hard-wired remote keypads, such as Extron's SCP 100P control panel (part #60-331-01, -02 or -03) can be connected via rear panel auxiliary ports. This accessory not only duplicates the functions of the System 5's front panel, it also receives IR signals from the IR 401 and transmits them to the System 5.
- **IR broadcast device** — A device such as Extron's IR Broadcaster (part #60-272-01) has a greater range than the IR Emitter and transmits signals over a wide area.

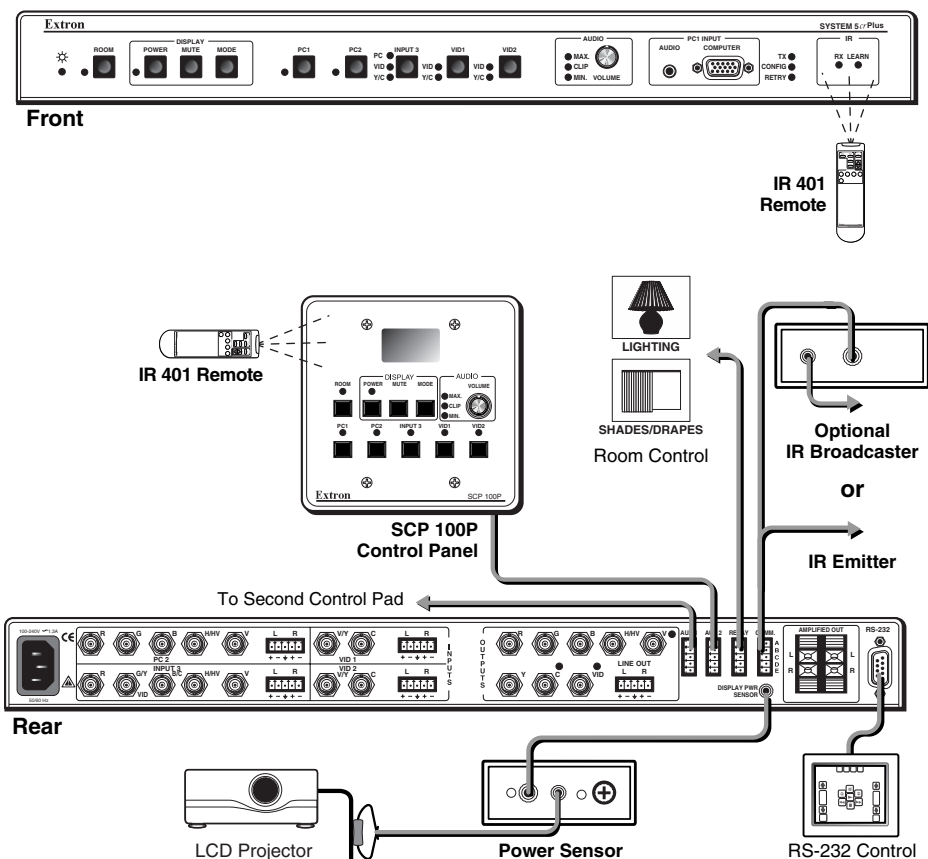

The System 5cr Plus (front and rear) with its options and accessories

Introduction, cont'd



System 5*α* Plus

Chapter Two

Installation

Mounting the Switcher
Cabling and Panel Views

Installation

Mounting the Switcher

The System 5cr Plus comes with two sets of mounting brackets. One set is for mounting the switcher under a table or on (against) a wall, and the other set is for rack-mounting.

Table/wall mounting

The table/wall-mounting brackets extend approximately 1/4" (6.3 mm) above the top surface of the System 5 enclosure, as shown below. This design allows for an air space between the enclosure and the surface on which it is mounted. Attach the table/wall-mounting brackets to the switcher with the provided machine screws, as shown below.

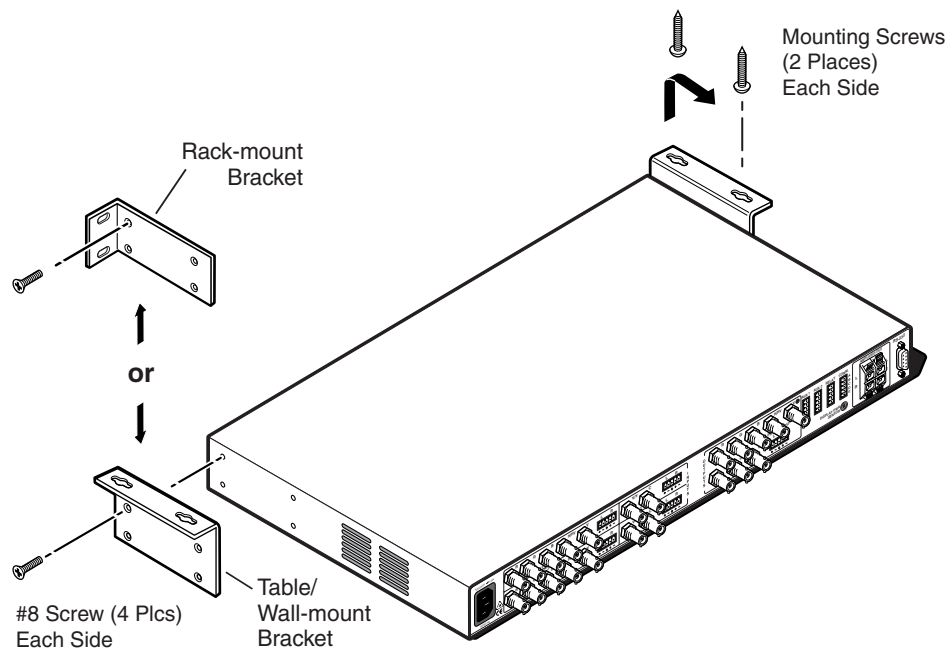

Mounting the System 5cr Plus

Rack mounting

The switcher can also be rack mounted. Attach the rack-mounting brackets to the switcher with the provided machine screws, as shown above, then fasten the switcher to the rack using the supplied machine screws.

Cabling and Panel Views

Power, video, and audio connections

With the exception of input PC 1 on the front panel, all input and output connectors are on the rear panel. The LEDs adjacent to the corresponding buttons on the front panel light when each input is active.

Front panel inputs

The PC 1 input on the front panel accepts computer video (RGBHV, RGBS or RGsB) through a VGA 15-pin HD connector, and unbalanced stereo audio through a 3.5 mm mini stereo jack, as shown in the illustration at left.

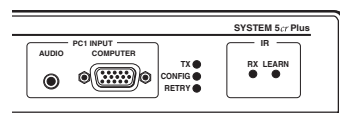

To wire the PC 1 audio input plug, follow the wiring diagram shown below.

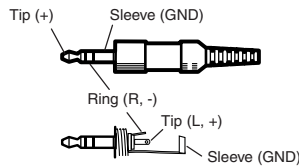

PC1 audio input plug wiring

Rear panel inputs

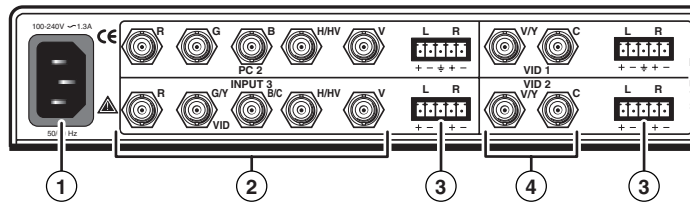

- ① **AC power connector** — Plug a standard IEC power cord into this port to connect the switcher to a 100 to 240VAC, 50 Hz or 60 Hz power source.
- ② **PC 2 and Input 3 computer video inputs** — These inputs accept VGA-type computer-video signals, and each has 5 female BNC connectors for RGB video input with composite or separate horizontal and vertical sync. Input 3 can be configured for RGB or S-video or composite video.

For PC 2:



For Input 3:

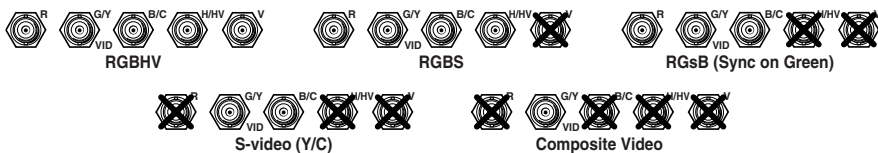

For S-video, connect the luma (Y) signal to the BNC connector marked G/Y and Vid, and the chroma signal (C) to the BNC marked B/C, as shown above.

NOTE Configure the video format via the front panel (see page 3-5) or using RS-232 programming (see chapter 4, 'Serial Communication').

- ③ **PC 2, Input 3, Vid 1, and Vid 2 audio inputs** — Each input has a 3.5 mm, 5-pole captive screw connector for balanced or unbalanced stereo audio input. Connectors are included with each System 5r, but the user supplies the audio cable. See the wiring diagrams below to wire a connector for the appropriate input type and impedance level. High impedance is generally over 800 ohms.

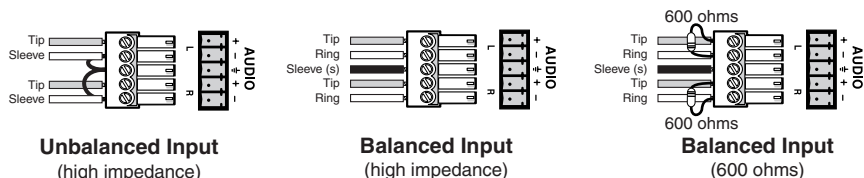
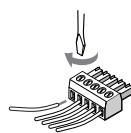

Captive screw connector wiring for rear panel audio inputs

Installation, cont'd

- ④ **Vid 1 and Vid 2 composite/S-video inputs** — Connect the cables as shown here. For S-video, connect the luma (Y) signal to the left BNC connector, marked V/Y, and the chroma signal (C) to the right BNC, marked C.



NOTE Configure the video format via the front panel or using RS-232 programming.

Outputs

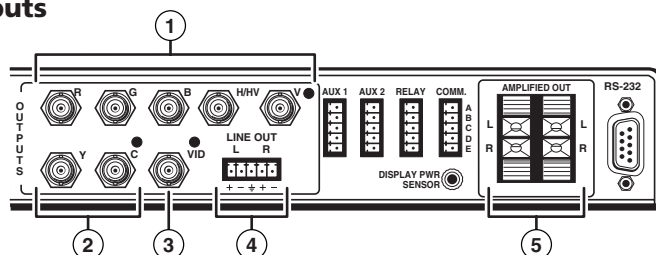

NOTE All three outputs can be connected simultaneously, although only one is active at a time. The output that is active is determined by the format of the active input.

NOTE The LED next to the connector(s) for each output (RGB, S-video, or composite video) lights when that output is active.

- ① **RGB output BNC connectors** — Connect coaxial cables from the display device to these BNCs for one RGBHV or RGBS video output as follows:



- ② **S-video output (Y, C)** — For S-video output, connect the cable for the luma (Y) signal to the Y connector, and the cable for chroma (C) signal to the C connector. A BNC-to-4-pin mini DIN (S-video) adapter may be required.
- ③ **Composite video output BNC (Vid)** — Connect the display device here, via a coaxial cable, for composite video output.
- ④ **Line level audio output (Line Out)** — For unamplified, line level audio output, connect an audio device, such as an audio recorder or powered speakers, to this 3.5 mm, 5-pole captive screw connector. Follow the wiring diagram below.

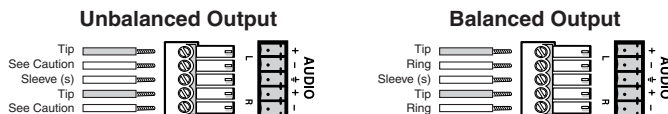

CAUTION Connect the sleeve to ground (Gnd). Connecting the sleeve to a negative (-) terminal will damage the audio output circuits.

The signal at this output comes from the selected audio input. The audio level from the Line Out output can either be variable (in response to front panel volume adjustment), or it can be set to a fixed level that is not affected by changes to the front panel volume adjustment. Use the Windows-based control program to change the output mode setting or to set audio breakaway. See chapter 4, *Serial Communication*, for details.

- ⑤ **Amplified audio output** — Connect unpowered speakers directly to these spring-loaded captive terminals for stereo output. Connect the left channels to positive/L, and the right channels to negative/R.

This output provides 24 watts of power (12 watts per channel with a 4 ohm load) or 12 watts (6 watts per channel with an 8 ohm load). The output level varies depending on the front panel volume adjustment.

Control device connections

NOTE Captive screw and 3.5 mm stereo jack connectors are included with the System 5, but the installer provides the cables.

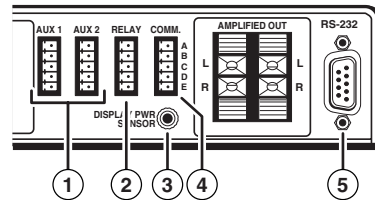

- ① **Auxiliary outputs (Aux 1, Aux 2)** — One optional external SCP 100P, SCP 250, or SCP/AAP A control panel can be connected to each of these 5-pole captive screw connectors. The control panel replicates the switcher's front panel control features. Wire the connectors as shown below.

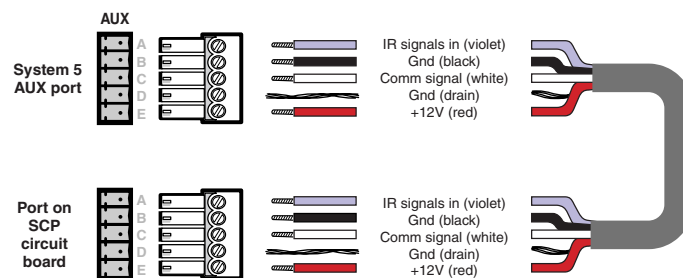

The Aux 1 and Aux 2 ports provide a total of 500 mA, split between the two ports, so each port provides 250 mA of current. Refer to the *SCP 100P User's Manual* (part #68-390-01) or the *SCP/AAP A, SCP 200, SCP 250 User's Manual* (part #68-511-01) for details about the control panels.

- ② **Room/relay port (Relay)** — This allows control of "room" functions – items such as room lighting, window coverings, and display screens – via momentary or latching contact. These contacts can be used to control any equipment as long as the contact specifications of a total of 24 volts at 1 ampere are not exceeded.

This port has two sets of contacts: one pair is closed by default, the other pair is open by default, as shown below.

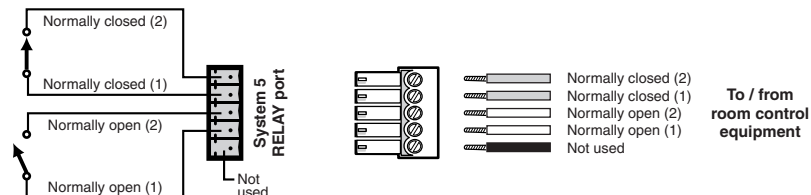

When the room function is active, the closed contacts open, and the open contacts close. Contacts can be programmed to operate in one of two ways:

- latching (brief contact) (press to turn on, press to turn off), or
- momentary (timed) (press to turn on, timeout to turn off).

In the timed mode the default timeout period is 1/8 second. Use the control software for Windows to change the length of the timeout period. See *Serial Communications*, chapter 4, for details.

Installation, cont'd

- ③ **Display power sensor port** — This mini stereo-style jack allows connection of an optional display power (current) sensor (Extron part #60-271-01). The power sensor is used to keep the projector and the System 5 in sync. Refer to the Power Sensor User's Guide, part #68-391-01, for information on operating the sensor.

WARNING *The power sensor port on the System 5 supplies +12VDC. To avoid electric shock when connecting the cable from the power sensor into the System 5, always connect the stereo jack at one end of the cable to the power sensor unit before plugging the jack at the other end into the System 5.*

The wiring connections are the same on both ends of the cable that connects the power sensor to the System 5. Wire the included connector as shown at left. Use a 3-wire cable.

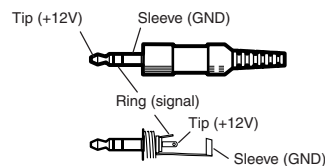

- ④ **Projector communications port (Comm)** — Connect the included IR Emitter or optional IR Broadcaster via this captive screw connector to send learned/uploaded IR signals (which differ from IR 401 remote control signals) to control the projector. The signals from the optional IR Broadcaster cover a wider area and greater distance than do those from the emitter, so it can be placed further from the projector. The IR Broadcaster is often used to replace the IR Emitter.

Wire the connector using one of the wiring options shown below.

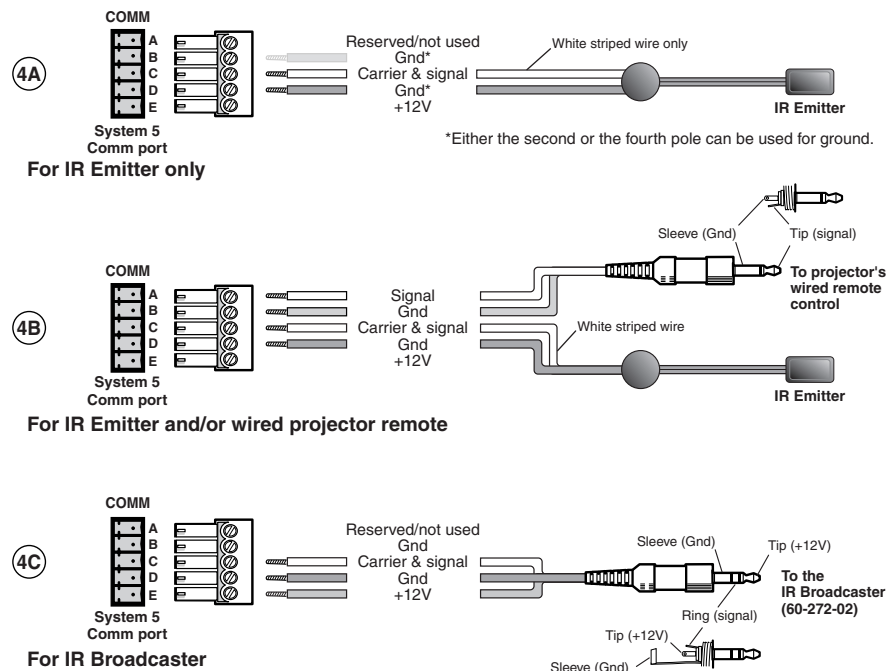

Projector communications (Comm) port connections

NOTE *For some projectors the emitter must be used together with the IR Broadcaster. Refer to the IR Broadcaster User's Guide (part #68-392-02) or contact an Extron support representative for details.*

- ⑤ **RS-232 port** — Connect a device such as a computer or touch panel control to the System 5 via this 9-pin D connector for serial RS-232 control. See the Serial Communications chapter for information on how to install and use the control software and the SIS commands.



System 5*cr* Plus

3

Chapter Three

Operation

Front Panel Controls and Indicators

Setting Up the System 5*cr* Plus

Remote Control of the System 5*cr* Plus

Setup and Operation

Front Panel Controls and Indicators

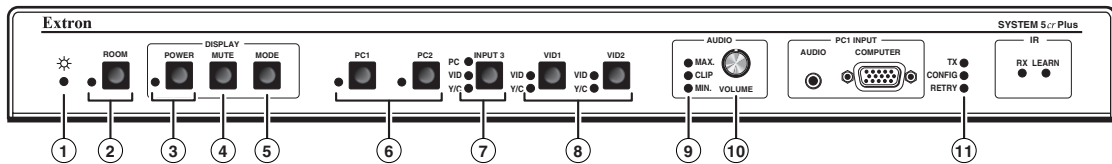

Most of the front panel controls described in this section also have another function during setup. See *Setting Up the System 5crPlus* in this chapter.

The SCP 100P remote keypad and the Windows-based control software replicate items 2 through 10 shown above, which are described in this chapter. The IR 401 remote control replicates the controls without the LEDs.

NOTE *When the System 5 powers up, all of the front panel LEDs light briefly, then turn off. The Power LED (1) lights and stays on until the System 5 is powered down. The LED for the last selected input, and the rear panel LED for the selected input format will light and remain on until the input is changed.*

- ① **Power LED** — This lights to indicate that the System 5 is receiving power.
- ② **Room button and LED** — This allows control of “room” functions – items such as room lighting, window coverings, and display screens – via momentary or latching contact through the Relay port. These contacts can be used to control any equipment as long as the contact specifications of a total of 24 volts at 1 ampere are not exceeded. The LED lights while the room function is active (on). See page 2-5 for information on the room/relay port, and see page 4-7 and refer to the Windows-based System 5cr Help program for details on changing settings.

Display function controls and LEDs

The settings of the display functions (power, mute, and mode) are customized for each projector. These buttons function only after they have been programmed, either by “learning” IR commands or by loading projector commands (drivers) from the Extron IR library.

- ③ **Display power (Power) button and LED** — Once the System 5 has been programmed with the commands for the specific projector, pressing this button toggles the projector’s power on or off.
The LED lights when projector power is on. The LED blinks quickly during projector power-up, and it blinks slowly during projector power-down. While the LED is blinking, do not send commands to the projector because the projector is not able to accept them. The blinking periods (power-up/down delay time) are generated within the System 5, not the projector. The blinking periods can be set only via the Windows-based control program.
- ④ **Display mute (Mute) button** — Press this button to toggle the projector’s “mute” function (to turn off/on the displayed image) once the Mute button has been programmed for use with the projector.
- ⑤ **Display mode (Mode) button** — This button can be programmed to switch the mode of the projector between computer-video (RGB), S-video, and composite video. It replicates the 1-button (step) mode function provided on some projectors’ remote controls.

Input selection controls and LEDs

Use these buttons to select the appropriate input source. LEDs next to each button indicate the format of the incoming video signal. Only the selected input’s LED

lights. If the System 5 has learned commands, it may send IR commands (such as a display mode change command) to the projector when an input is selected.

- ⑥ **PC 1 and PC 2** — Press these buttons to select input 1 (PC 1, front panel) or input 2 (PC 2, rear panel), respectively. Both inputs accept only RGB computer-video and audio.
- ⑦ **Input 3** — This button corresponds to Input 3 (rear panel), which can be configured to accept audio and RGB, or S-video, or composite video. The LED corresponding to the selected format lights when Input 3 is selected.
- ⑧ **Vid 1 and Vid 2** — Press these buttons to select input 4 (Vid 1) or input 5 (Vid 2), respectively. Both of these rear panel inputs can be configured to accept audio and either S-video or composite video.

NOTE *Audio breakaway (the ability to separately switch audio and video signals from different inputs) is available only via the RS-232 control. While audio breakaway is active, the flashing LED indicates the input providing the audio signal, and the steadily lit LED indicates the active video input.*

Audio adjustment control and LEDs

- ⑨ **Audio indicator LEDs (Max, Clip, and Min)** — These LEDs light in response to changes made via the front panel volume control knob or RS-232 or control software commands.

Max LED (red) – This LED lights when the volume control knob has reached its maximum limit. It does not indicate anything about the audio level.

Clip LED (green) – This LED lights when the audio output level starts to peak (overdrive) and the signal is clipped, often when the input level is too high. It is used mostly during audio input attenuation setup.

Min LED (red) – This LED lights when the volume control knob has reached its minimum limit. It does not indicate the audio level.

- ⑩ **Volume control knob** — Turn this to adjust the audio volume (audio gain) for the amplified output. The volume control knob can be used as a master volume control for both audio outputs if all the audio inputs have the same level. There is no physical limit to this knob's rotation. The Min or Max LED will light briefly when the knob has reached its functional minimum or maximum limit.

Audio gain/attenuation can be set per input via the front panel controls or via RS-232 commands or the Windows-based control program. For details, see *Setting Up the System 5crPlus* in this chapter, and chapter 4, *Serial Communication*.

Infrared control LEDs

- ⑪ **IR function LEDs (Tx, Config, Retry)** — These three LEDs indicate stand-alone functions and also are used in combinations during IR learning. For example, all three LEDs flash at once to indicate a timeout when the System 5 is in configuration mode. See *Setting Up the System 5crPlus* in this chapter for details on when the LEDs light in combination.

Transmit (Tx) LED (green) – This lights while the System 5 transmits infrared signals.

Configure (Config) LED (amber) – This lights steadily when the System 5 is in setup (configuration) mode.

Retry LED (red) – This lights when the System 5 does not recognize a command during the infrared learning process.

Setup and Operation, cont'd

Setting Up the System 5 α Plus

The System 5 α Plus must be set up (configured) before it can control other equipment. Setup can be done from the front panel, or from a computer using the provided control software. Setup cannot be done via the IR 401 remote control or the SCP 100P control pad.

Extron provides preset configurations in the form of projector driver files that can be downloaded from diskette or the Extron website. See "Downloading and using projector drivers" in chapter 4 for details. Projector drivers assign projector IR commands to the System 5's front panel controls so that the display power, mute, and mode functions can be used to control the projector.

Configuring the System 5 α Plus from the front panel

The System 5 must be in the setup (config) mode during setup. The Config LED lights when the setup mode is on. The following configuration procedures can be performed from within setup mode:

- clear an individual button's IR function configurations,
- clear *all* System 5 settings,
- set audio input attenuation levels,
- select video formats,
- initiate IR learning.

See the flowcharts in this section for the specific steps for setting up the System 5.

NOTE When there has been no activity for at least 20 seconds, the System 5 times out from the setup mode to the normal mode, and the Tx, Config, and Retry LEDs will all flash for 5 seconds.

Clearing configurations

Clearing configuration settings resets them to factory defaults. To clear configurations, see the flowchart below.

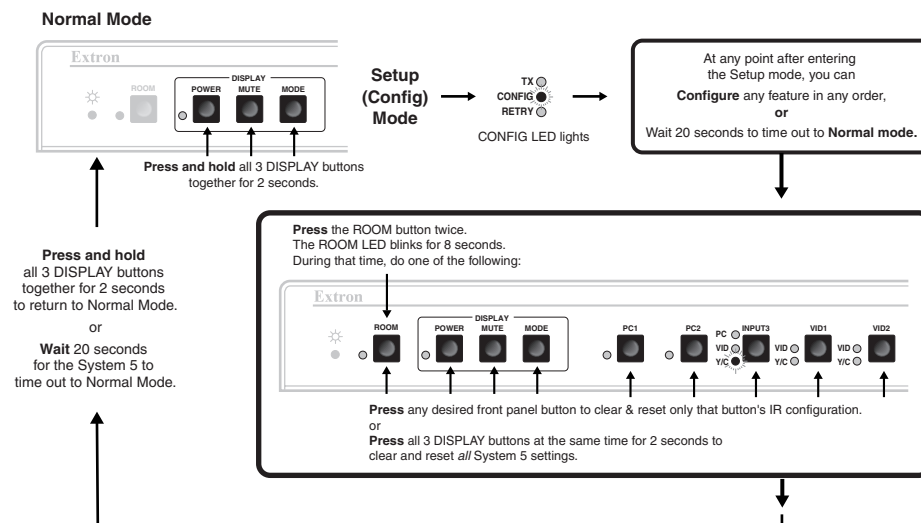

NOTE Pressing all three Display buttons clears and resets **all** configuration settings to the factory defaults. These settings include Display functions, IR commands, room settings, video type, RGB delay, power up/down delay, room relay mode, audio gain, and all other settings.

Setting audio input attenuation levels

Before setting the audio levels, ensure that all the audio input sources are active and connected to the System 5. To set the audio levels, see the following flowchart.

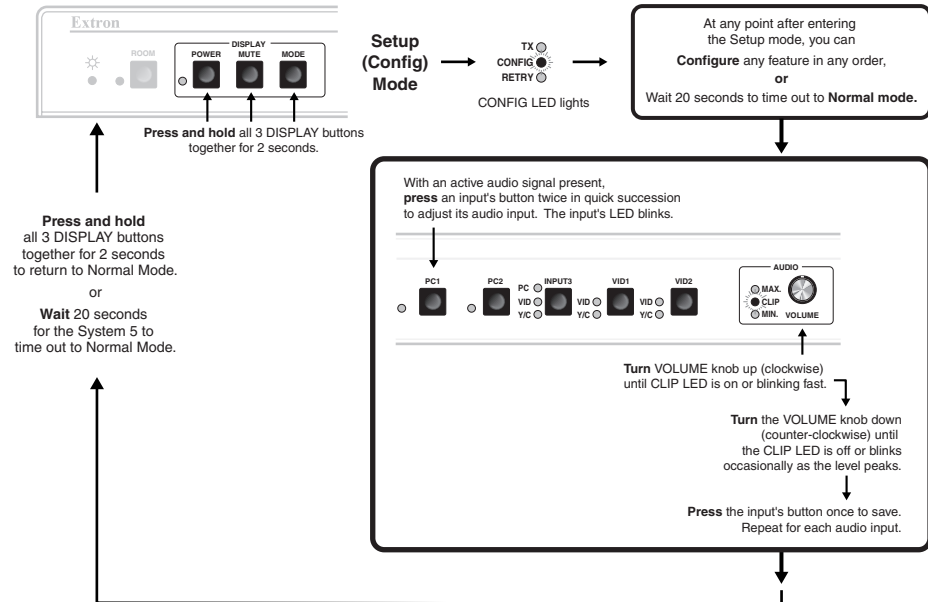

Selecting video formats

Input 3 can be set to accept computer-video (RGB), S-video (Y/C), or composite video (Vid, V). Vid 1 (input 4) and Vid 2 (input 5) can be set for S-video or composite video. Select the format as shown below.

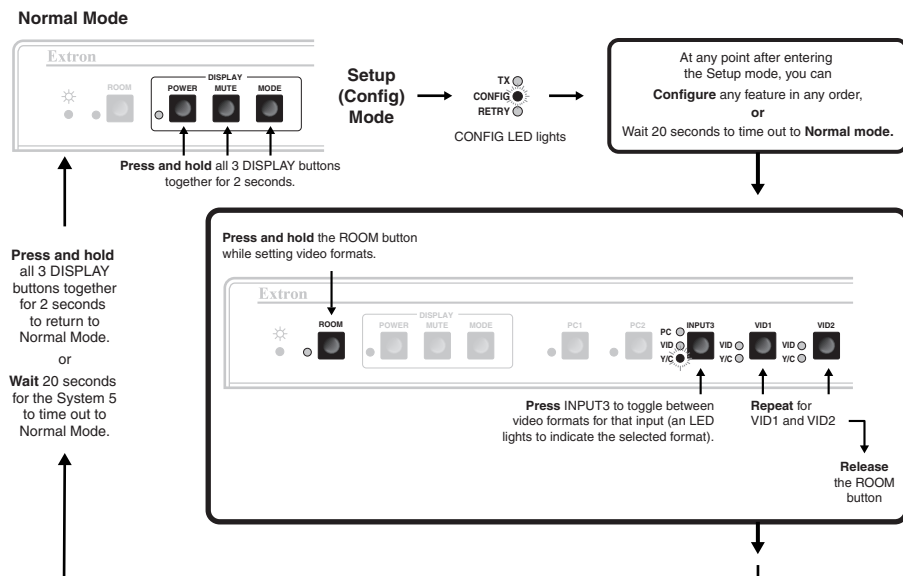

Setup and Operation, cont'd

Initiating IR learning

The System 5 can “learn” control commands from projectors’ remote controls. IR learning is only necessary if there is no IR driver available for that projector or if the driver is not complete.

The System 5cr Plus has two portholes on its front panel:

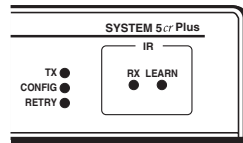

- one for the IR receiver (Rx), which receives signals from the IR 401 remote; and
- one for the IR learning device (Learn), which receives signals from a projector’s remote control during IR learning.

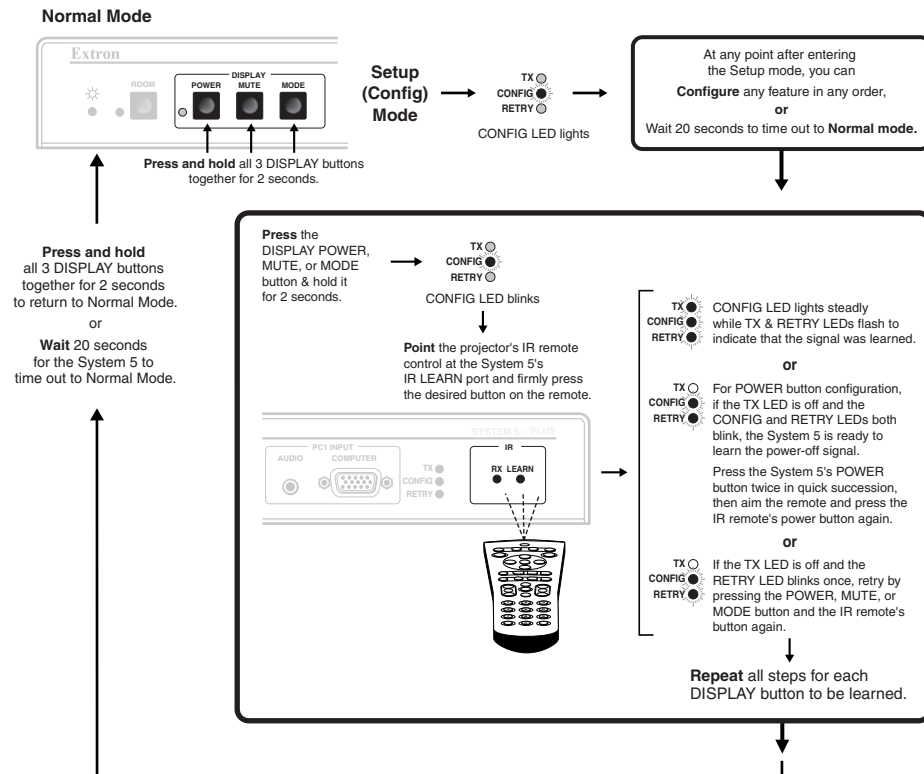

During IR learning you might need to hold the projector’s IR remote control as near to the System 5 as one-half inch and point the remote directly at the IR learning (Learn) device. Blocking ambient light from the IR learning device, particularly from fluorescent lights, can also help.

NOTE Once the System 5 has been programmed to control the projector, do not perform the learned projector control functions from the projector or the projector’s remote control. The System 5 will not know that projector control commands have been sent by an external device. For example, if a projector is powered on via the System 5, and then the projector is manually turned off at the projector’s panel, the System 5 will not know the projector is off, and it will continue to send video signals and commands to the projector.



To interpret the System 5's response to the IR learning steps, see the LED response codes below.



Key to LED Codes

Status	Setup mode is active	Ready to learn IR commands	Command has been learned	Try again	No IR subcarrier was received	Ready to learn the power-off command	Timeout exit to normal mode will occur
TX 	Off	Off	Blinks once	Off	Off	Off	Blinks for 5 seconds
CONFIG 	On	Blinking	On	On	On	Blinking	Blinks for 5 seconds
RETRY 	Off	Off	Blinks once	Blinks once	Blinking	Blinking	Blinks for 5 seconds
What to do next	Configure a System 5 feature.	Aim projector's remote at IR learning port. Press a button for the function on the remote.	Continue with setup or exit to normal mode.	Press the same button again on the projector's IR remote.	Press the same System 5 Display button again, and press the IR remote's button again.	Double-click the System 5's Display Power button, then press the power button on the projector's remote.	Press any button to stay in setup mode.

Remote Control of the System 5 α Plus

The System 5 can be controlled by using its front panel controls, the included IR 401 infrared remote control, optional SCP remote control panels, or an RS-232 control device or computer.

The IR 401 and SCP control panels replicate the System 5's front panel controls for normal mode operations. The RS-232 control device also can send front panel normal mode commands. A computer using Extron's Windows-based control program can perform both normal mode and setup mode operations, and it offers some functions that are not available with the other control methods. See chapter 4, *Serial Communication*, for details.

The IR 401 uses  and  buttons in place of the volume knob. It also has an audio mute button.

Setup mode operations can *not* be performed from the IR 401.

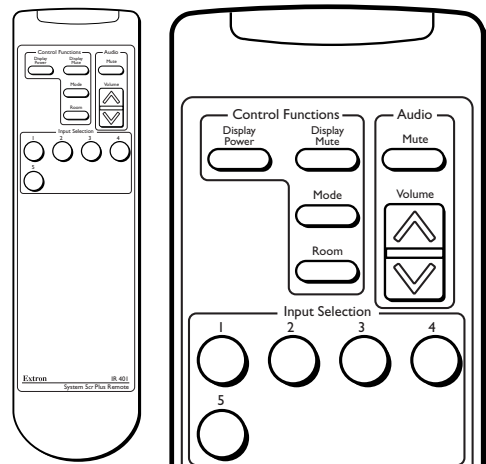

The SCP 100P, SCP/AAP A, and SCP 250 can be mounted in a wall or furniture. Each includes an IR remote window (corresponding to the IR receiver port on the System 5) or IR signal pickup device for receiving commands from the IR 401 remote control and sending them to the System 5. Infrared signals from other devices are not passed on to the IR Emitter or the IR Broadcaster. Up to two SCPs can be connected to the System 5.

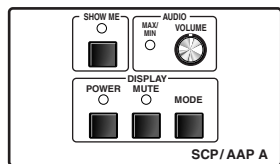

Setup and Operation, cont'd

Setup mode operations can *not* be performed from the SCP control panel(s).

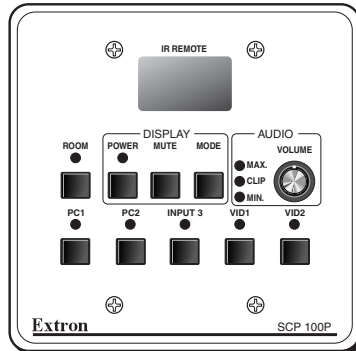

Refer to the *SCP 100P User's Manual* (part #68-390-01) or the *SCP/AAP A, SCP 200, SCP 250 User's Manual* (part #68-511-01) for details about the control panels.

NOTE *The SCP 250 can also be used with the Extron System 7SC switcher. When the SCP 250 is used with the System 5cr Plus, the last three buttons are not used.*

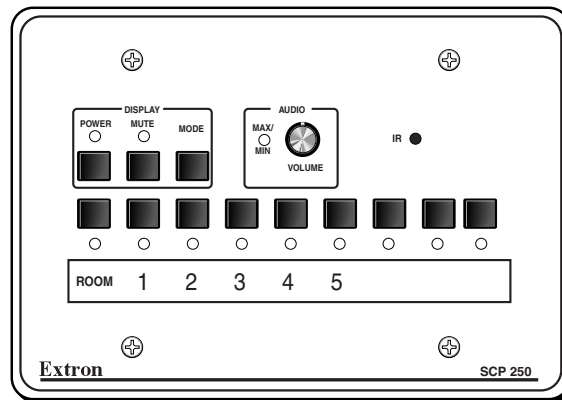



System 5 α Plus

4 Chapter Four

Serial Communication

RS-232 Programmer's Guide

Control Software for Windows

Serial Communication

The System 5cr Plus can be remotely controlled via a host computer or other device (such as a control system) attached to the rear panel RS-232 connector. The control device (host) can use either Extron's Simple Instruction Set (SIS) commands or the graphical control program for Windows.

The System 5 switcher uses a protocol of 9600 baud, 1 stop bit, no parity, and no flow control.

The rear panel RS-232 9-pin D connector has the following pin assignments:

Pin	RS-232 function	Description
2	Tx	Transmit data
3	Rx	Receive data
5	Gnd	Signal ground

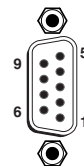

DB9 Pin Locations
Female

RS-232 Programmer's Guide

Host-to-switcher communications

SIS commands consist of one or more characters per field. No special characters are required to begin or end a command sequence. When the System 5cr Plus determines that a command is valid, it executes the command and sends a response to the host device. All responses from the switcher to the host end with a carriage return and a line feed (CR/LF = ↵), which signals the end of the response character string. A string is one or more characters.

Switcher-initiated messages

When a local event such as a front panel (or SCP control pad) selection or adjustment takes place, the System 5 switcher responds by sending a message to the host. No response is required from the host. The switcher-initiated messages are listed here (underlined).

(C) Copyright 2000, Extron Electronics, System 5cr Plus, Vx.xx ↵

The System 5 sends the copyright message when it first powers on. Vx.xx is the firmware version number.

RECONFIG ↵

When a change is made via a front panel control or another operation occurs that must be written to a new memory block, the System 5 sends the reconfiguration message. No response is required from the RS-232 host, but the host may request a new status listing via the request information command (I/i). See the command/response table in this chapter for details.

C [x] ↵ (where [x] is the input number)

The System 5 sends this response when an input is switched. C = both audio and video were switched.

Error responses

When the switcher receives a valid SIS command, it executes the command and sends a response to the host device. If the System 5 is unable to execute the command because the command is invalid or it contains invalid parameters, it returns an error response to the host.

The error response codes and their descriptions are as follows:

- E01 – Invalid input channel number (the number is too large)
- E10 – Invalid command
- E13 – Invalid value (the number is out of range/too large)
- E16 – Unit is busy
- E23 – Checksum error.

Using the command/response tables

The command/response tables on the next page list valid command ASCII codes, the switcher’s responses to the host, and a description of the command’s function or the results of executing the command. Lower case characters are acceptable in the command field only where indicated.

ASCII to HEX Conversion Table										Esc 1B	CR 0D	LF 0A		
20	!	21	“	22	#	23	\$	24	%	25	&	26	‘	27
(28)	29	*	2A	+	2B	,	2C	-	2D	•	2E	/	2F
0 30	1	31	2	32	3	33	4	34	5	35	6	36	7	37
8 38	9	39	:	3A	;	3B	<	3C	=	3D	>	3E	?	3F
@ 40	A	41	B	42	C	43	D	44	E	45	F	46	G	47
H 48	I	49	J	4A	K	4B	L	4C	M	4D	N	4E	O	4F
P 50	Q	51	R	52	S	53	T	54	U	55	V	56	W	57
X 58	Y	59	Z	5A	[5B	\	5C]	5D	^	5E	_	5F
` 60	a	61	b	62	c	63	d	64	e	65	f	66	g	67
h 68	i	69	j	6A	k	6B	l	6C	m	6D	n	6E	o	6F
p 70	q	71	r	72	s	73	t	74	u	75	v	76	w	77
x 78	y	79	z	7A	{	7B		7C	}	7D	~	7E	DEL	7F

The ASCII to HEX conversion table at left is for use with the command/response tables.

ASCII to Hex conversion table

Serial Communication, cont'd

The command/response tables use symbols (defined below) to represent variables.

Symbol definitions

- ↵ = CR/LF (carriage return/line feed) (hex 0D 0A)
- = Space
- [X1] = Input number (0 through 5)
 - 0 = no connection
 - 1 = PC 1
 - 2 = PC 2
 - 3 = Input 3
 - 4 = Vid 1
 - 5 = Vid 2
- [X2] = 0 = off, 1 = on
- [X3] = Display power status (0 through 3)
 - 0 = display power is off
 - 1 = display power is on
 - 2 = display is powering down
 - 3 = display is powering up
- [X4] = Audio attenuation steps (0 through 100)
- [X5] = Which configurable video input (3 through 5)
 - 3= Input 3 Input 3 can be composite video, S-video, or RGB.
 - 4 = Vid 1 Vid 1 can be composite video or S-video.
 - 5 = Vid 2 Vid 2 can be composite video or S-video.
- [X6] = Video input signal type (0 through 2)
 - 0 = RGB
 - 1 = composite video
 - 2 = S-video
- [X7] = Switcher main controller firmware version (listed to two decimal places e.g.: x.xx), followed by IR firmware version

Command/response table for SIS commands

Command description	Command ASCII	Command Hex	Response (switcher to host)	Additional description
Input selection				
Select both video and audio	[X1] !	30 + [X1] 21	C [X1] ↵	Video & audio input [X1].
Select audio only	[X1] \$	30 + [X1] 24	A [X1] ↵	Audio input [X1].
Select video only	[X1] &	30 + [X1] 26	V [X1] ↵	Video input [X1].
Room function				
Turn room function on	O	4F	Rly [X2] ↵	On.
Turn room function off	o	6F	Rly [X2] ↵	Off.
Display (projector) power				
Turn display power on	[5B	Pwr [X3] ↵	On (discrete).
Turn display power off]	5D	Pwr [X3] ↵	Off (discrete).
Display mute				
Toggle display mute on/off	S/s	53/73	Mut ↵	Use S or s to toggle mute.
Display mode				
Toggle display mode	J	4A	Mde ↵	
Audio gain/attenuation				
Increase audio gain	{G	7B 47	Aud [X4] ↵	Increment up (amp output).
Decrease audio gain	}G	7D 47	Aud [X4] ↵	Increment down (amp out.).
Set amp output gain	0*[X4] G	30 2A [X4] 47	Aud [X4] ↵	Affects master output volume.
Set input attenuation	1*[X4] G	31 2A [X4] 47	Aud [X4] ↵	Adjusts the active input's gain.
Read attenuators	*A	2A 41	[X4] • [X4] • [X4] • [X4] • [X4] ↵	Displays the attenuation status for audio inputs PC 1, PC 2, Input 3, Vid 1, and Vid 2, in that order.
Video configuration				
Set video signal type	[X5]*[X6] \	[X5] 2A [X6] 5C	Vid/Y-C/RGB ↵	Set signal type for Input 3, Vid 1, or Vid 2.
Firmware version, part number, & information requests				
Query firmware version number	Q/q	51/71	Ver [X7] • [X7] ↵	Display controller and IR firmware version.
Request part number	N/n	4E/6E	N60-269-02 ↵	Display switcher's part #.
Request information	Command = I/i	49/69	(see below)	Display status.
	Response =	V [X1] • A [X1] • T [X6] • Pwr [X3] • Rly [X2] • Clp [X2] • Amt [X2] • Aud [X4] ↵		
	Note:	Amt is audio mute.		

**Command/response table for advanced instructions
(for the control program for Windows)**

Command	Hex. command (host to switcher)	Response (switcher to host)	Additional description
IR block			
Read (upload)	80 83	8k bytes of data	
Write (download)	80 82 [8 kbytes]	Dnl ↵	Downloads 8 kbytes.
Flag block			
Read (upload)	80 85	15 bytes of data	Example:
Write (download)	[Byte0]*[Byte1] 91	Flg ↵	To set byte 0 to 21 and byte 1 to 100, send the following command: 30 32 31 2A 31 30 30 91 _{hex} The byte value range is 0-255.
	[Byte2]*[Byte3] 93	Flg ↵	
	[Byte6]*[Byte7] 97	Flg ↵	
	[Byte8]* 30 99	Flg ↵	
Unit reset			
Reset unit	80 81	Upd ↵	

Flag block

The flag block consists of fifteen bytes (0 to 14) that will be used for handling special operation functions.

- Byte 0 – Power on delay
- Byte 1 – Power off delay
- Byte 2 – Triple-action switching delay (0.5 second * value)
- Byte 3 – Relay control
- Byte 4 – Not used
- Byte 5 – Not used
- Byte 6 – Not used
- Byte 7 – Mute control and various flags
 - Bit 7 – true = mute audio upon display power-down
 - Bit 6 – true = limit initial system volume (upon switcher power-up)
 - Bit 5 – true = send responses to RS-232 commands
 - Bit 4 – true = send channel change IR command upon display power-up
 - Bit 3 – false = disable front panel volume knob
 - Bit 2 – false = disable IR while display power is off
 - Bit 1 – false = fixed Line Out output level (1 = volume knob controls Line Out)
 - Bit 0 – unused

NOTE *The factory default for byte 7 is all bits set to On (hex FF).*

- Byte 8 – Video type (composite video, S-video, or RGB)
 - Bit 5 = video 5 mode
 - 0 = video
 - 1 = S-video
 - Bit 4 = video 4 mode
 - 0 = video
 - 1 = S-video
 - Bit 3 = reserved
 - Bits 2 & 1 = video 3 mode
 - 00 = RGB
 - 01 = S-video
 - 10 = video
 - 11 = undefined
 - Bit 0 = reserved
- Byte 14 – Checksum

Serial Communication, cont'd

Control Software for Windows

Installing the software

The included graphical control software for Windows offers another way to control the System 5 via RS-232 connection in addition to the Simple Instruction Set commands. The control program's graphical interface includes the same functions as those on the switcher's front panel and some additional features that are only available through the Configure Unit screen of the Windows-based software.

The control software is compatible with Windows 95/98, and Windows NT. Extron's System 5cr Control Program is included with the System 5, and updates can be downloaded from the Extron website (<http://www.extron.com>).

The control program is contained on two 3.5-inch diskettes, and it requires approximately 2 MB (megabytes) of hard disk space.

To install the software on the hard drive:

1. Run SETUP.EXE from the floppy disk.
2. Follow the instructions that appear on the screen.

By default the installation creates a C:\System5 directory, and it places two icons (SYSTEM 5cr Control Pgm and SYSTEM 5cr Help) into a group or folder named "Extron Electronics".

Using the software

Using the control program

1. To run the control program, double-click on the SYSTEM 5cr Control Pgm  icon in the Extron Electronics group or folder. The Comm menu appears on the screen.
2. Click on the comm port that is connected to the System 5cr Plus' RS-232 port. (A view-only emulation mode is also available.) The Extron SYSTEM 5cr Control Program window appears. It displays the current settings. There are three views available:

- the *main screen (Normal Mode)*; the default mode, shown below, which allows all normal mode front panel functions;

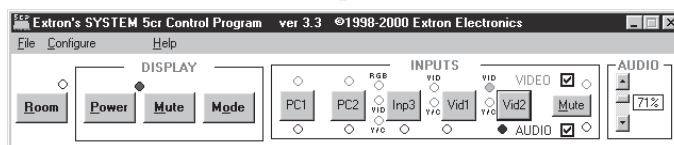

- *Executive Mode* screen, shown below, which allows input selection only;

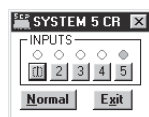

and

- *Configure Unit* screen, shown on the next page, which includes all front panel functions plus additional configuration options that are part of the setup (config) mode. Some operations can be done only via this part of the Windows-based program.

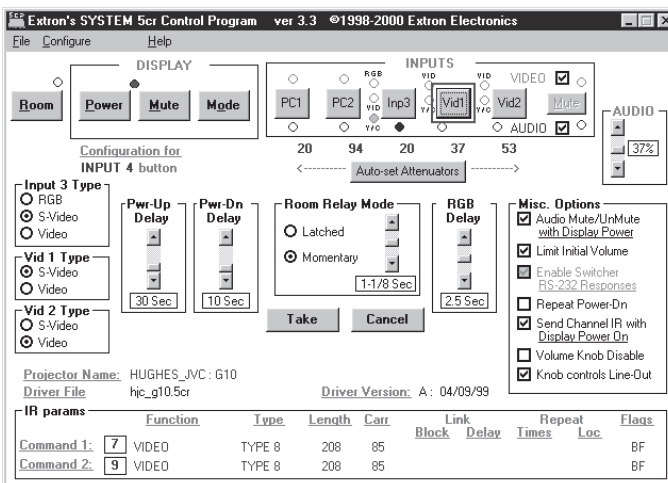

Power-up/down delay, room relay mode, auto-set attenuators, RGB delay, and miscellaneous options are adjustable only via the *Configure Unit* control screen. Refer to the System 5cr Help program for details on setting these options.

Power Up/Down Delay — This feature does not control the projector in any way. It simulates projector delays from 10 seconds to 5 minutes (adjusted in 10-second increments). For a projector that has a warm-up or cool-down cycle during which it will not accept commands, adjust the System 5's power-up or power-down delay time to match that of the projector. During the delay time, the Power LED will blink as a reminder to not send commands to the projector.

Room relay modes — Select one of the two room relay modes (latched or momentary) to change how the room relay operates. The default is momentary contact for 1/8 second.

- Select Latched to require a press of the Room button to toggle the relay on or toggle it off.
- Select Momentary to allow the relay to automatically turn off after a set period time, of from 1/8 second to 2 seconds. Pressing the Room button will turn the relay on, and the relay will automatically shut off when the period ends.

RGB delay — This is used in Triple-Action (video mute) switching. With Triple-Action switching, the System 5 switches to the new sync signal before switching RGB (video) signals. That allows the projector to adjust to the new sync timing during a brief delay before displaying the new picture, which will appear without glitches. The blanking period (RGB delay time) can be set to a period from 0 seconds to 5 seconds (in half-second steps) via the *Configure Unit* screen.

Saving and restoring configurations

The System 5 can be configured by various means (IR learning, downloading, front panel adjustment, or combinations of those methods), and the configuration settings can be saved to a file for later use.

1. In the System 5cr Control Program, select File, then select Save Configuration as... .
2. Save the file as *(filename).sy5*. An unlimited number of configuration files can be saved as long as each file has a unique file name ending in *.sy5*.
3. To retrieve the configuration from within the System 5cr Control Program, select File, then select Restore Configuration from... .

Serial Communication, cont'd

Using the help program

For information on program features, press the F1 computer key, or click on the  Help menu from within the System 5cr control program, or double-click on the SYSTEM 5cr Help icon in the Extron Electronics group or folder.

For explanations of buttons or functions, click on a link at the bottom of the main help screen to reach the *Configure Unit* or *Executive Mode* screens, or remain in the main screen. Use a mouse or the Tab and Enter keys to select a button/function. A description will appear on screen.

To learn how to use the help program, select Using Help from the Help menu or press the F1 key from within the Help program.

Downloading and using projector drivers

The System 5cr Plus must be set up (configured) before it can control other equipment. Extron provides preset configurations in the form of projector driver files. Projector drivers assign projector IR commands to the System 5's front panel controls so that the display power, mute, and mode functions can be used to control the projector.

The most recent projector driver files are available at the Extron website at <http://www.extron.com>. To download files to computer, do the following:

1. From the Extron website, select Download, then select System 5cr Projector Drivers.
2. Locate the model of projector for which a driver is needed, and click on the file name of the driver used by that projector.
3. Follow the instructions that appear on screen.
4. If the projector driver has been successfully downloaded, the projector driver will be displayed in the *Configure Unit* screen of the Windows-based control program. It will also appear in the list of available projector drivers when Restore Configuration from... is selected from the Windows-based control program's File menu.

To view the settings and commands in each projector driver file without loading the driver into the System 5, run the System 5 control software in emulation mode.

1. Double-click on the SYSTEM 5cr Control Pgm icon in the Extron Electronics group or folder. The Comm menu appears on the screen.
2. Select Emulate instead of one of the comm ports.
3. Select and double-click on the desired projector driver in the (drive):\System5\drivers folder. Projector driver filenames end in .5cr.

To load projector drivers into the System 5, do the following:

1. Upon opening the control program, select and double-click on a comm port instead of emulation mode.
2. Select the File menu.
3. Select Restore Configuration from... and choose the appropriate driver.



System 5*α* Plus

A

Appendix

Appendix

Specifications

Part Numbers and Accessories

Firmware Upgrade Installation

Glossary

Appendix

Specifications

Video

Gain	Unity
Bandwidth	250 MHz (-3dB)
Frequency response	< ± 0.1dB @ 30 MHz
Differential phase error	0.01°, 0 to 10 MHz
Differential gain error	0.01%%, 0 to 10 MHz
Crosstalk	-50dB @ 5 MHz

Video input

Number/signal type	2 RGBHV/RGBS/RGsB computer video 1 RGBHV/RGBS/RGsB computer video or S-video or composite video 2 S-video or composite video
Connectors	1 15-pin HD female (RGB computer video) 2 x 5 BNC female (RGB computer video; RGB/S-video/composite video) 2 x 2 BNC female (S-video or composite video)
Minimum/maximum levels	Analog 0.3V to 2V p-p with no offset
Impedance	75 ohms
Horizontal frequency	15 kHz to 150 kHz
Vertical frequency	30 Hz to 150 Hz
Return loss	-45dB @ 5 MHz
Maximum DC offset	1.5V

Video output

Number/signal type	1 RGBHV/RGBS/RGsB, or 1 S-video, or 1 composite video
Connectors	1 x 5 BNC female (RGB computer video) 1 x 2 BNC female (S-video) 1 x 1 BNC female (composite video)
Minimum/maximum levels	0.3V to 2.0V p-p
Impedance	75 ohms
Return loss	-38dB @ 5 MHz
DC offset	±5mV maximum with input at 0 offset
Switching type	Triple-Action

Sync

Input type	RGBHV, RGBS, RGsB
Output type	RGBHV, RGBS, RGsB
Standards	TTL (RGB), NTSC and PAL (S-video and composite video)
Input level	0.5V to 5V p-p
Output level	0.5V to 5V p-p
Input impedance	75 ohms
Output impedance	75 ohms
Max input voltage	5V p-p
Max. propagation delay	20 nS
Polarity	Positive or negative (follows input)

Audio

Gain	Unbalanced/balanced -78dB to +40dB
Frequency response	20 Hz to 20 kHz, ± 0.05 dB
THD + Noise	<0.1% @ 1 kHz at rated maximum output drive
S/N	>95dB, at rated maximum output drive
Crosstalk	<-80dB @ 1 kHz, fully loaded
Stereo channel separation	>90dB @ 1 kHz
CMRR	>75dB @ 20 Hz to 20 kHz

Audio input

Number/signal type	5 stereo, balanced/unbalanced
Connectors	1 3.5 mm mini stereo jack (PC 1) 4 3.5 mm captive screw connectors, 5 pole
Impedance	>50 kohms unbalanced, 25 kohms balanced
Maximum level	+20dBu, (balanced or unbalanced) at stated %THD+N
Input gain adjustment	-10dB to +6.5dB, adjustable per input

Audio output — line out

Number/signal type	1 stereo, balanced/unbalanced
Connectors	1 3.5 mm captive screw connector, 5 pole
Impedance	50 ohms unbalanced, 100 ohms balanced
Maximum level (Hi-Z)	>+21dBu, balanced or unbalanced at stated %THD+N
Maximum level (600 ohm)	>+15dBm, balanced or unbalanced at stated %THD+N

Audio output — power amp

Number/signal type	1 stereo, unbalanced
Connectors	2 spring-loaded captive terminals, L/R, +/-
Protection	Thermal, short circuit, open circuit, overload
Maximum level (full power out) ..	At less than 0.5% THD from 20-20kHz: 24 watts; 12 watts per channel @ 4 ohm load 12 watts; 6 watts per channel @ 8 ohm load

NOTE 0dBu = 0.775 volts (RMS).

Control/remote — switcher

Serial control port	RS-232, 9-pin female D connector
Baud rate and protocol	9600, 8-bit, 1 stop bit, no parity
Serial control pin configurations	2 = TX, 3 = RX, 5 = GND
Extron remote key pad control ..	2 5 mm, 5-pole captive screw connectors (Aux ports)
IR controller module	30 kHz to 60 kHz input frequency compatibility
Program control	Extron's control program for Windows Extron's Simple Instruction Set™ – SIS™

Control — room relay

Number/type	1 momentary or latching
Connectors	1 3.5 mm captive screw connector, 5 pole
Contact rating	24V, 1 A

Control — projector

Projector control port (IR)	1 3.5 mm captive screw connector, 5 pole
-----------------------------------	------------------------------------------

Appendix, cont'd

General

Power	100VAC to 240VAC, 50/60 Hz, 70 watts, internal, auto-switchable
Temperature/humidity	Storage -40° to +158°F (-40° to +70°C) / 10% to 90%, non-condensing Operating +32° to +122°F (0° to +50°C) / 10% to 90%, non-condensing
Rack mount	Yes, with included brackets
Enclosure type	Metal
Enclosure dimensions	1.75" H x 17.5" W x 9.4" D (1U high, full rack width) 4.4 cm H x 44.4 cm W x 23.9 cm D (Depth excludes connectors.)
Product weight	6.1 lbs (2.7 kg)
Shipping weight	11 lbs (5.0 kg)
Vibration	ISTA/NSTA 1A in carton (International Safe Transit Association)
Listings	UL, CUL
Certifications	CE
MTBF	30,000 hours
Warranty	3 years parts and labor

NOTE Specifications are subject to change without notice.

Part Numbers and Accessories

Included parts

These items are included in each order for a System 5cr Plus switcher:

Included parts	Part number
System 5cr Plus	60-269-02
Rack mounting bracket kit	70-077-03
Table mounting bracket kit	70-077-01
IR Emitter	19-823-01
IR 401 remote control	70-144-01
3.5 mm, 5-pole captive screw connectors	10-319-10
System 5cr Plus User's Manual	68-498-01

Accessories

These items can be ordered separately

Accessories	Part number
IR Broadcaster	60-272-01
Current/display power sensor	60-271-01
SCP 100P (gray, black, white)	60-331-01, -02, -03
SCP 250 (gray, black, white)	60-356-01, -02, -03
SCP/AAP A (gray, black, white)	60-339-01, -02, -03

Firmware Upgrade Installation

In some cases the System 5's firmware may require replacement with an updated version. The two user-replaceable firmware chips are U1, the main microcontroller, and U7, the carrier signal generator.

WARNING *Changes to firmware must be performed by authorized service personnel only.*

Follow these steps to replace firmware in the System 5.

1. Disconnect the AC power cord from the System 5 to remove power from the unit.

WARNING *To prevent electric shock, always unplug the System 5 switcher from the AC power source before opening the enclosure.*

2. Remove the switcher from the rack, wall, or furniture.
3. Remove the cover of the switcher (the top half of the enclosure) by removing the screws, then lifting the cover straight up.

WARNING *Do not touch any switches or other electronic components inside the switcher. Doing so could damage the switcher. Electrostatic discharge (ESD) can damage IC chips even though you cannot feel it. You must be electrically grounded before proceeding with firmware replacement. A grounding wrist strap is recommended.*

4. Locate chips U1 and U7 on the front panel circuit board, as shown below.

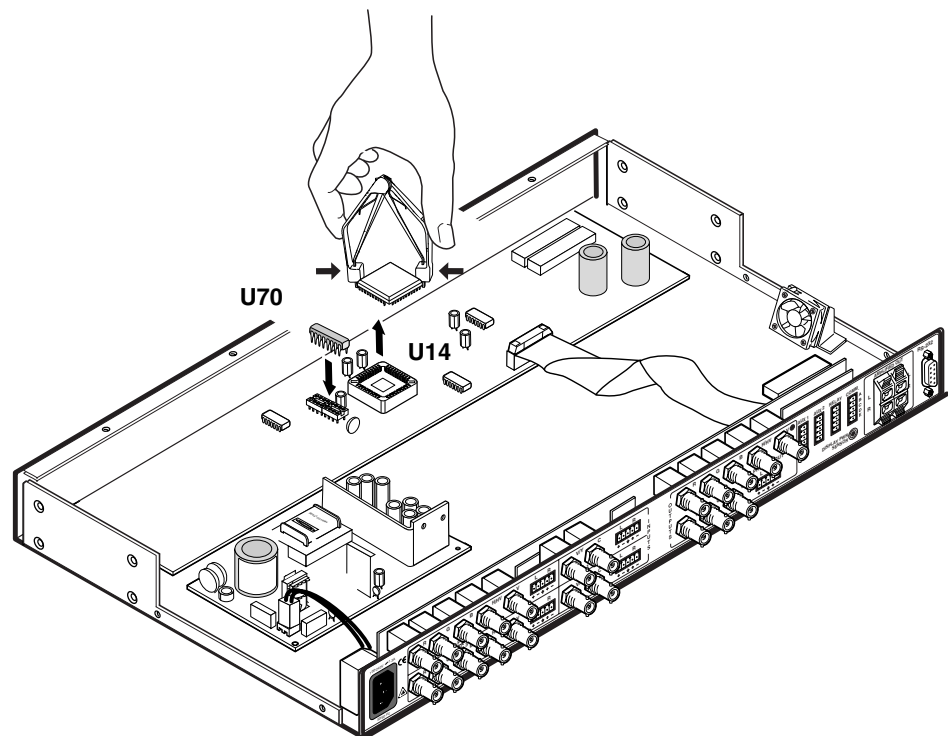

Locating firmware IC chips U1 and U7, and aligning the PLCC chip puller tool with firmware chip slots

5. After you are electrically grounded, align the hooks of a PLCC IC puller tool with the slots located in diagonally opposite corners of the firmware chip that you wish to upgrade.

Appendix, cont'd

6. Insert the hooks into the slots, and squeeze the tool gently to grasp the chip.
7. Pull the chip straight out of the socket, and set it aside.
8. Align the slots of the new firmware IC chip with the angled corners of the socket in the same orientation as the old chip.
9. Gently but firmly press the chip into place in the socket.
10. If you are replacing both firmware chips, repeat steps 5 to 9 for the other chip.
11. Replace the top cover on the System 5 switcher, and fasten it with the screws that were removed in step 3.
12. Rack mount the switcher, and reconnect the AC power cord.

Glossary

Attenuate/attenuation — To reduce the amplitude (strength) of a signal or current.

Balanced audio — A method that uses three conductors for one audio signal. They are plus (+), minus (-), and ground. The ground conductor is strictly for shielding, and does not carry any signal. Balanced audio is also called “differential audio”.

Bandwidth — A frequency range, or “band” of frequencies between the limits defined by the “half power points”, where the signal loss is -3dB. In audio and video, it is this band of frequencies that can pass through a device without significant loss or distortion. The wider the bandwidth, the better the quality that results, such as a sharper picture or better sound. The higher the bandwidth number, the better the performance. (300 MHz is better than 250 MHz.) When a signal passes through a path with more than one device (including cables), the limiting factor (bottleneck) in that path is the device with the narrowest bandwidth.

Breakaway — The ability to separate audio and video signals for switching them independently. For example: the audio and video signals from one source may “break away” and be switched to two different destinations.

Buffer — Generally referred to as a unity gain amplifier, a buffer is used to isolate the signal source from the load. A buffer can be used for digital or analog signals.

Clipping — Cutting off the peaks (or excursions) of a signal. A form of distortion that occurs when the signal excursions exceed the limits of the circuit, and the signal flattens out.

Clipping level — An electronic limit (short of the distortion point) to which audio should be set to avoid overdriving an audio signal. Setting the clipping level appropriately allows headroom for maintaining signal fidelity.

IR learning — The ability of a device, such as Extron’s System 5cr Plus, to receive and store infrared commands for other devices, such as a projector. Each command is assigned to a system operation (such as selecting an input). When an operation is executed, the associated (learned) command is then transmitted through an IR emitter or broadcaster to the projector, where it is executed.

IR library — Sets of downloadable infrared commands (drivers) for video projectors available at Extron’s web site (<http://www.extron.com>).

Latching — The System 5 room relay can operate in two modes: latching or momentary. In the latching mode, the relay remains active (latched) until it is manually reset (unlatched).

Level — The relative intensity (strength, voltage, volume) of an audio or video signal. The output level can be changed by attenuation (a decrease relative to the input signal) or gain (an increase in the signal level).

RGB delay — This is used in Triple-Action (video mute) Switching. With triple-action switching, the System 5 switches to the new sync signal before switching RGB (video) signals. That allows the projector to adjust to (lock onto) the new sync timing during a brief delay before displaying the new picture, which will appear without glitches.

Appendix, cont'd

Extron's Warranty

Extron Electronics warrants this product against defects in materials and workmanship for a period of three years from the date of purchase. In the event of malfunction during the warranty period attributable directly to faulty workmanship and/or materials, Extron Electronics will, at its option, repair or replace said products or components, to whatever extent it shall deem necessary to restore said product to proper operating condition, provided that it is returned within the warranty period, with proof of purchase and description of malfunction to:

**USA, Canada, South America,
and Central America:**

Extron Electronics
1230 South Lewis Street
Anaheim, CA 92805, USA

Asia:

Extron Electronics, Asia
135 Joo Seng Road, #04-01
PM Industrial Bldg.
Singapore 368363

Europe, Africa, and the Middle East:

Extron Electronics, Europe
Beeldschermweg 6C
3821 AH Amersfoort
The Netherlands

Japan:

Extron Electronics, Japan
Daisan DMJ Bldg. 6F,
3-9-1 Kudan Minami
Chiyoda-ku, Tokyo 102-0074
Japan

This Limited Warranty does not apply if the fault has been caused by misuse, improper handling care, electrical or mechanical abuse, abnormal operating conditions or non-Extron authorized modification to the product.

If it has been determined that the product is defective, please call Extron and ask for an Applications Engineer at (714) 491-1500 (USA), 31.33.453.4040 (Europe), 65.6383.4400 (Asia), or 81.3.3511.7655 (Japan) to receive an RA# (Return Authorization number). This will begin the repair process as quickly as possible.

Units must be returned insured, with shipping charges prepaid. If not insured, you assume the risk of loss or damage during shipment. Returned units must include the serial number and a description of the problem, as well as the name of the person to contact in case there are any questions.

Extron Electronics makes no further warranties either expressed or implied with respect to the product and its quality, performance, merchantability, or fitness for any particular use. In no event will Extron Electronics be liable for direct, indirect, or consequential damages resulting from any defect in this product even if Extron Electronics has been advised of such damage.

Please note that laws vary from state to state and country to country, and that some provisions of this warranty may not apply to you.



www.extron.com

Extron Electronics, USA

1230 South Lewis Street
Anaheim, CA 92805
USA
714.491.1500
Fax 714.491.1517

Extron Electronics, Europe

Beeldschermweg 6C
3821 AH Amersfoort
The Netherlands
+31.33.453.4040
Fax +31.33.453.4050

Extron Electronics, Asia

135 Joo Seng Road, #04-01
PM Industrial Building
Singapore 368363
+65.6383.4400
Fax +65.6383.4664

Extron Electronics, Japan

Daisan DMJ Building 6F
3-9-1 Kudan Minami
Chiyoda-ku, Tokyo 102-0074 Japan
+81.3.3511.7655
Fax +81.3.3511.7656